



HKBN Unified Communications T61P SIP Phone User Guide



Contents

Getting Start of Phone	2
Phone Package	2
Assembling the phone	2
SIP Phone Button	4
SIP Phone Screen Display	5
Icon Instruction	5
Basic Call Features	9
Placing a Call	9
Answering a Call	9
Ending a Call	10
Volume Adjustment	10
Redial	10
Call Mute and Un-mute	10
Call Hold and Resume	10
Call Transfer	11
Call Conference	11
Local Call History	12
Call Forwarding	12
Forward to Specific Number	12
Forward to Voice Mail	12
Remote Call Forward	13
Voice Mail Service	14
Voice Mail Indicator	14
Access Voice Mail	14
Voice Mailbox Main Menu	14
Reply Message	15
Advanced Call Features	16
Call Waiting	16
Speed Dialing	16
Do-not-disturb	17
Call pick up	17
Support	18
Contact Us	18

Getting Start of Phone

Phone Package

The following items are included in your package:

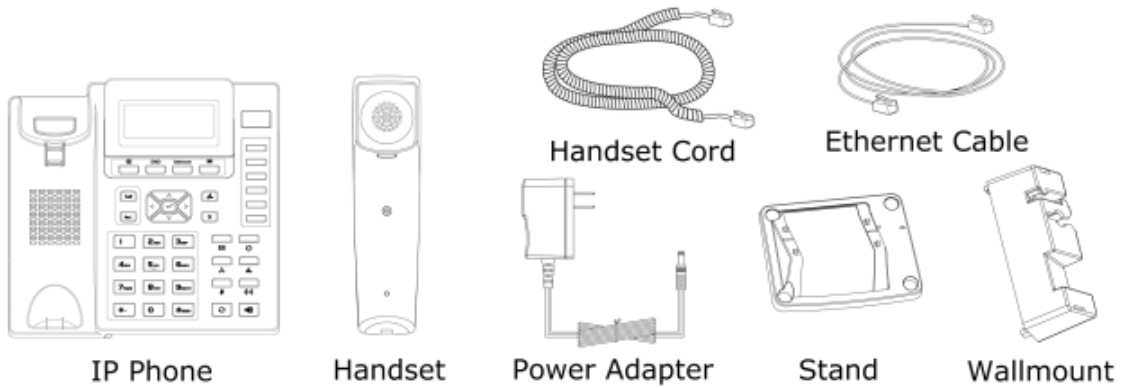

Assembling the phone

Attach the stand:

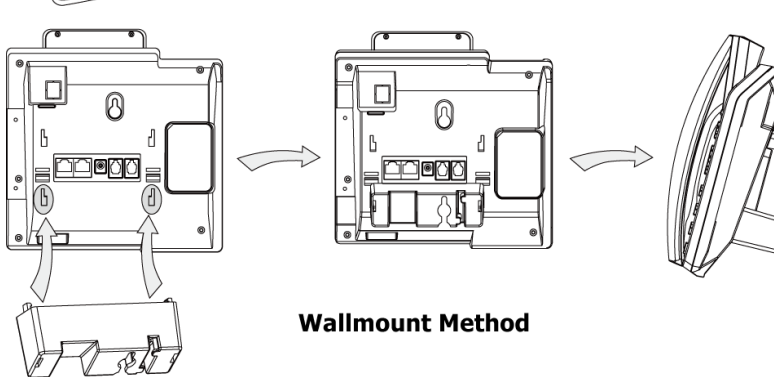
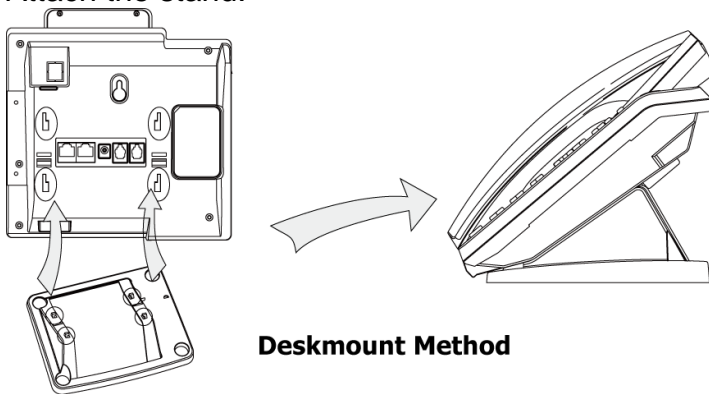

Connect the handset and optional headset:

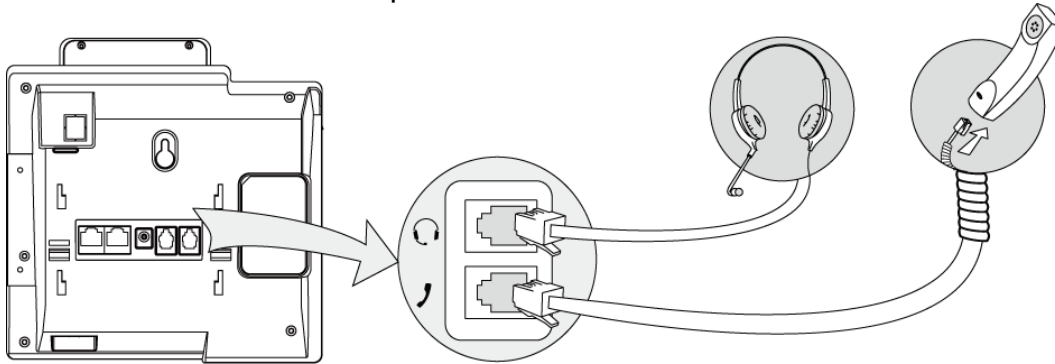

Connect the network and power:

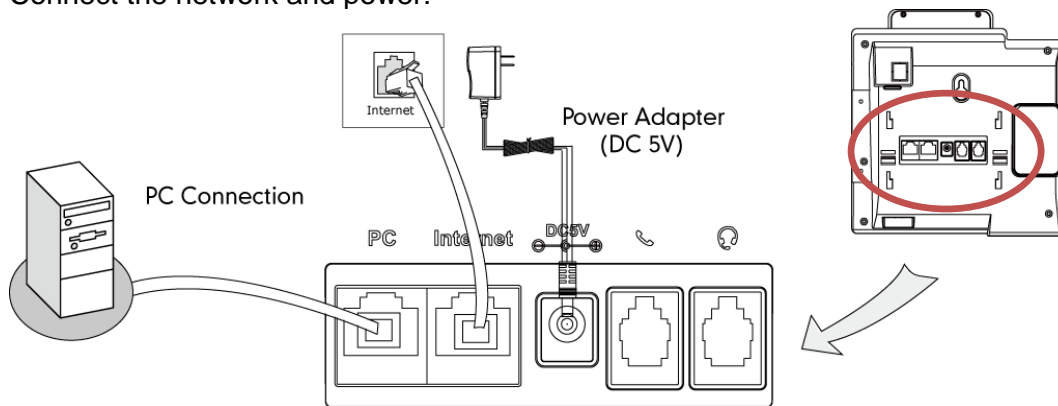

Notes: SIP Phone cannot function properly when there is a failure in power supply and internet network outage

SIP Phone Button

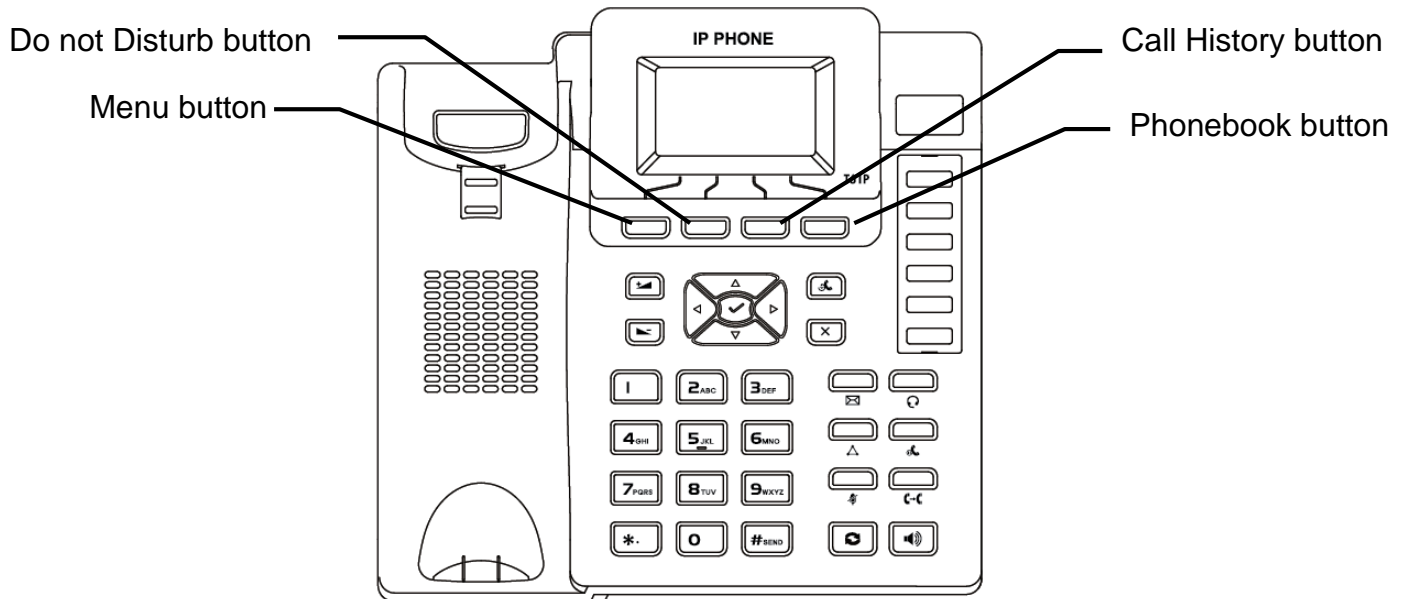

Menu button :

- Press this button to open the menu.
- In menu, press this button to go to upper level / quite.
- Press this button to end call.
- Press this button to stop dialing.

Do not Disturb button :

- Press this button to enable DND mode, then the phone rejects all calls.
- Press careful to use this feature, in order to avoid missing the incoming call.

Call History button :

- Press this button to open the local call history menu.

















Phonebook button :

- Press this button to open the phonebook.
P.S. This is the SIP phone's local phonebook which will not synchronize from/to UC Communication Manager.





SIP Phone Screen Display



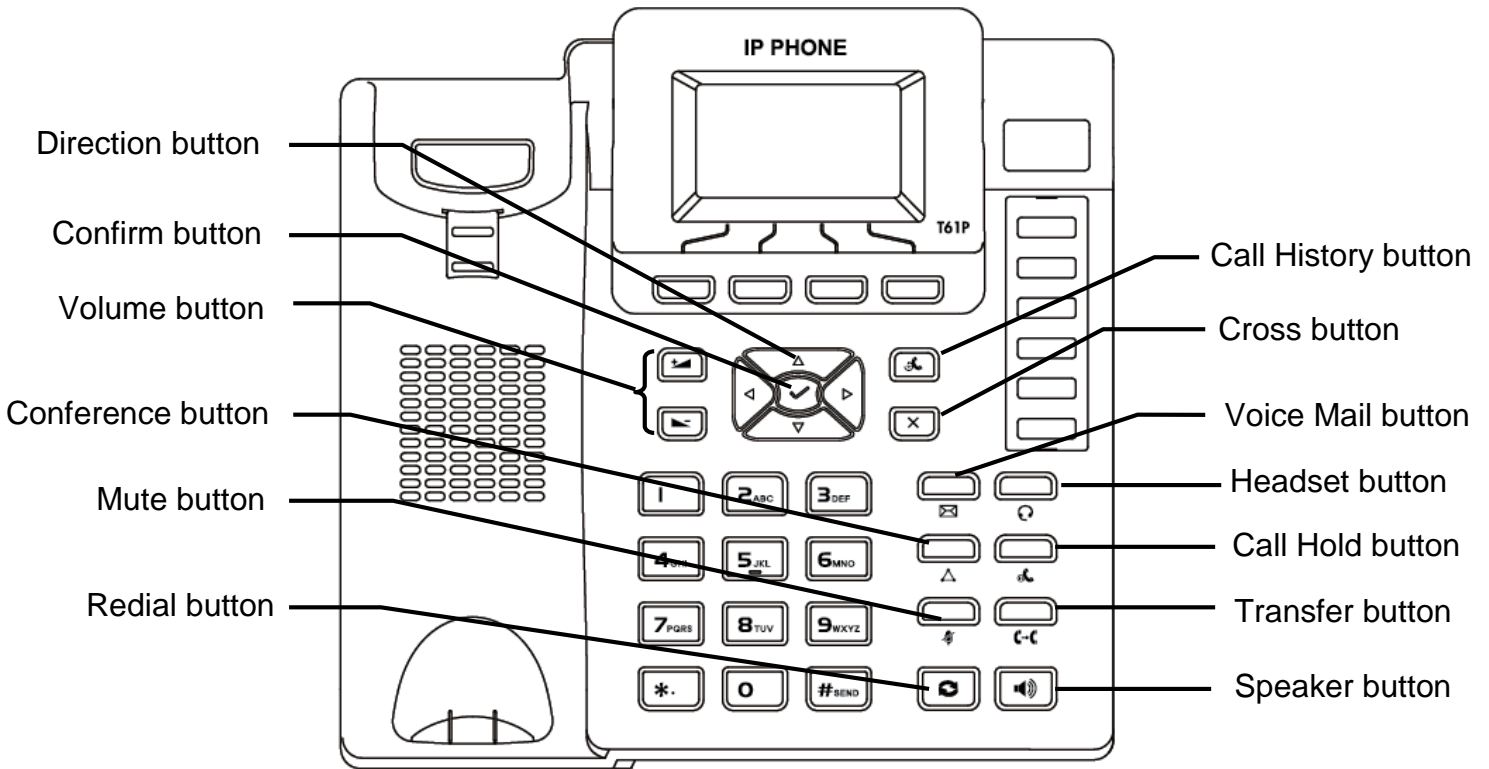





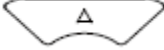
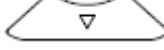

Icon Instruction



The IP Phone displays different kinds of icons on its LCD. You can refer to the following table for their meanings:

Icon	Description
	Flashes when the Internet is disconnected / Network is unavailable <i>Note: You can check the LAN cable connecting to the Internet port on the phone</i>
	Account register failed <i>Note: Please contact HKBN for support</i>
	Account registering <i>Note: Please contact HKBN for support</i>
	Account register successful
	You have Missed call(s)
	Call in <i>Note: it will be displayed while checking the call history</i>
	Call out <i>Note: it will be displayed while checking the call history</i>
	You have enabled Call Mute function <i>Note: The other side will fail to hear any voice</i>
	You are holding a Call
	You have new voice mail(s)
	You have enabled the phoneset's DND(Do not Disturb) functions <i>Note: All incoming calls will be rejected</i>
	You have enabled the phoneset's Auto answer setting <i>Note: All incoming call will be auto answered. General users are not recommended to activate this function</i>
	The phoneset is in handset mode
	The phoneset is in headset mode
	The phoneset is In Speakerphone mode
	Ringer volume is 0



Button	Description
	Volume button (Gain) : <ul style="list-style-type: none"> - When the phone is idle, press this button to make the phone ring louder, and increase button pressing sound. - When the phone is pickup, press this button to gain handset volume. - When the speaker is active, press this button to gain speaker volume.
	Volume button (loss) : <ul style="list-style-type: none"> - When the phone is idle, press this button to make the phone ring quiet, and decrease button pressing sound. - When the phone is pickup, press this button to lower handset volume. - When the speaker is active, press this button to lower speaker volume.
	Call History button : <ul style="list-style-type: none"> - When the phone is idle, press this button to open all call history.
	Cross button : <ul style="list-style-type: none"> - In call history, press this button to delete record. - During number dialing, press this button to backspace. - During user input, press this button to backspace. - In function menu, press this button to cancel





	<p>Direction Upward button :</p> <ul style="list-style-type: none"> - Select upper item in menu. - Select waiting call.
	<p>Direction Downward button :</p> <ul style="list-style-type: none"> - Select lower item in menu. - Select waiting call.
	<p>Direction Leftward button :</p> <ul style="list-style-type: none"> - Select left hand side item in menu. - Move backward in user input.
	<p>Direction Rightward button :</p> <ul style="list-style-type: none"> - Select right hand side item in menu. - Move forward in user input.
	<p>Confirm button :</p> <ul style="list-style-type: none"> - Press this button to confirm the selected item. - Pick up the waiting call. - Send the dialed number.
	<p>Voice Mail button :</p> <ul style="list-style-type: none"> - Press this button to listen the voice mail.
	<p>Headset button :</p> <ul style="list-style-type: none"> - Press this button to use the headset to make / receive call.
	<p>Conference button :</p> <ul style="list-style-type: none"> - Press this button to hold existing call, and start to dial 3rd party number - After 3rd party is dialed, press this button again to connect all 3 parties.
	<p>Call Hold button :</p> <ul style="list-style-type: none"> - Press this button to hold existing call. - Press this button again to resume held call.
	<p>Mute button :</p> <ul style="list-style-type: none"> - Press this button to mute the microphone to stop other side to listen the voice.
	<p>Transfer button :</p> <ul style="list-style-type: none"> - Press this button to hold existing call, and transfer to 3rd party. - Dial 3rd party number after press this button once. - Press this button again to transfer the call away the phone.

	<p>Redial button :</p> <ul style="list-style-type: none">- When the phone is idle, press this button to check the dialed number.- When the phone is picked / speaker is open, press this button to redial last number.
	<p>Speaker button :</p> <ul style="list-style-type: none">- When the phone is idle, press this button to open / close speaker.- When the phone is ringing, press this button to answer call with speaker.- When the phone is taking, press this button to swap between speaker and handset.

Basic Call Features

Placing a Call

There are 3 ways for placing a new call:

- Using the handset:
 1. Pick up the handset.
 2. Enter the number, and then press 
- Using the speakerphone:
 1. With the handset on-hook, press 
 2. Enter the number, and then press 
- Using the headset:
 1. With the headset connected, press  to activate the headset mode.
 2. Enter the number, and then press 

Note:

For Centrex user (with Extension setting), to call an extension number, you are just need to enter the target extension number. To call non-extension number, you need to add "9" before telephone number, for example, 9+61234567.

During a call, you can alternate between headset, hands-free speakerphone and handset modes by pressing the Headset key or the Speakerphone key or picking up the handset. Headset mode requires a headset connected.

Answering a Call

There are 3 ways for answering a call:

- Using the handset:

Pick up the handset.
- Using the speakerphone:





Press 
- Using the headset:

Press 

Note: You can reject an incoming call by pressing the X button.





Ending a Call

There are 3 ways for ending a call:

- Using the handset:
Hang up the handset or press 
- Using the speakerphone:
Press  or 
- Using the headset:
Press 





Volume Adjustment

You can also change the speaker / handset volume to suit your talking environment:

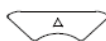
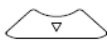

1. Press  or  during a call to adjust the receiver volume of handset / speakerphone / headset.
2. Press  or  when the phone is idle to adjust the ringer volume.

Redial

To redial the most recently dialed number:

1. Press  to enter the Dialed Calls list, press  or  to select the desired call, and then press  or .
2. Press  twice when the phone is idle to call the last dialed number.

Call Mute and Un-mute



1. Press  to mute the microphone during a call.
2. Press  again to un-mute the call.

Call Hold and Resume

To place a call on hold:



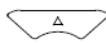
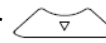





- Press  during an active call.

To resume the call, do one of the following:

- If there is only a call on hold, press .
- If there is more than one call on hold, press  or  to select the desired call  and then press .

Call Transfer



You can transfer a call in the following ways:

- Blind Transfer
 1. Press  during an active call. The call is placed on hold.
 2. Enter the number you want to transfer to.
 3. Press 
- Semi-Attended Transfer
 1. Press  during an active call. The call is placed on hold.
 2. Enter the number you want to transfer to, and then press 
 3. Press  when you hear the ring-back tone.
- Attended Transfer
 1. Press  during an active call. The call is placed on hold.
 2. Enter the number you want to transfer to, and then press 
 3. Press  when the second party answers.

Call Conference



Conference calling facilitates the communication between various parties.

Choose to add third party to an existing conversation anytime you wish.

1. Press  during an active call. The call is placed on hold.
2. Enter the number of the second party, and then press 
3. Press  again when the second party answered. All parties are now joined in the conference.
4. Hang up the handset to disconnect all parties.



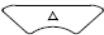
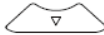

You can split the conference by,



1. Press “**Split**” to split the conference call into 2 individual calls (both calls will put on hold)
2. Press  or  to select the call you want to end
3. Press “**End Call**” to end the selected call
4. Press  or “**Resume**” resuming the remaining call.

Local Call History

Your SIP Phone will store your missed, placed and received call log in the internal call log memory.

1. Press  when the phone is idle, press  or  to scroll through the list.
2. Select an entry from the list, you can do the following:
 - Press  to place a call.
 - Press  to delete the entry from the list.

Call Forwarding

Forward to Specific Number

Use Call Forward to direct your calls to any local phone numbers of your choice:
P.S. Forwarding to a overseas phone number is not permitted

1. All Calls Forward
 - Activate: Press *81 + telephone number
 - Cancel: Press #81
2. Busy Calls Forward
 - Activate: Press *82 + telephone number
 - Cancel: Press #82
3. No Answer Calls Forward
 - Activate: Press *83 + telephone number
 - Cancel: Press #83

<p><i>Note: You may need to add "9" before telephone number as similar to make outgoing call for Centrex user. For example, *81+9+61234567.</i></p>

Forward to Voice Mail

Use Call Forward to direct your calls to your voice mail on your phoneset:

1. All Calls Forward
 - Activate: Press *77
 - Cancel: Press #77
2. Busy Calls Forward
 - Activate: Press *78
 - Cancel: Press #78
3. No Answer Calls Forward
 - Activate: Press *79
 - Cancel: Press #79

Remote Call Forward

This feature allows users to activate and de-activate Call Forward via a remote telephone.

1. Dial 21368282
2. Enter your telephone number
3. Enter your password

P.S. The default password is "0000", and we strongly suggested customer to change the password once the first attempt by calling to 21331238.

In the Remote Call Forward main menu, there are 2 options:

- Press 1 to Set / Cancel All Call Forward
- Press 2 to set **Presence**

Under Set / Cancel All Call Forward Menu:

- Press 1 to set All Call Forward to specific number
- Press 2 to set All Call Forward to voice mail
- Press 3 to cancel All Call Forward

Under Set **Presence** Menu:

- Press 1 to set **Presence** to **Office**
- Press 2 to set **Presence** to **Meeting**
- Press 3 to set **Presence** to **Outside**
- Press 4 to set **Presence** to **Scheduled**

Note: For the detail of Presence, please refer to Communication Manager Portal Manual.

Note: It is highly recommended to use the access code to perform call forwarding rather than SIP phone menu configuration.

Voice Mail Service

Voice Mail Indicator

The Message Waiting Indicator on the idle screen indicates that you have new voice messages waiting. The Message key LED lights up.

Access Voice Mail

You can access Voice Mail by following 2 ways:

- Press *90
- Press 

Then:

- Enter your password + #;
P.S. The default password is "0000", and we strongly suggested customer to change the password once the first attempt by calling to 21331238.

Voice Mailbox Main Menu

- Press "1" to listen to message;
Then, {
 - Press "1" to rewind to the beginning of message;
 - Press "3" to go to the end of message;
 - Press "4" to replay message;
 - Press "5" to listen message information;
 - Press "6" to record message to reply;
 - Press "7" to delete message;
 - Press "8" to forward message to other mailbox;
 - Press "9" to save message;
 - Press "*" to go back to main menu;
- Press "2" to change mailbox feature;
Then, {
 - Press "1" to change password;
 - Press "2" to select greeting;
Then, {
 - Press "1" to select system greeting;
 - Press "2" to select name announcement greeting;
 - Press "3" to select personalized greeting;
 - Press "9" to activate / cancel password;
Then, {
 - Press "1" to skip password feature;
 - Press "2" to activate password feature
 - Press "*" to go back to main menu;
- Press "5" to retrieve message(s) from other voice mailbox;

- Press “8” to change mailbox language;
 - Then, {
 - Press "1" to select Cantonese;
 - Press "2" to select English;
 - Press “3” to select Mandarin;
 - Press "*" to go back to main menu;

- Press “9” to change system greeting language for caller;
 - Then, {
 - Press "1" to establish / change 1st language;
 - Press "2" to establish / change 2nd language;
 - Press "3" to establish / change 3rd language;
 - Press "*" to go back to main menu;

- Press “*” to end;

Reply Message

- Follow instruction to record the reply message;
 - Then, {
 - Press "*" to erase message and record again;
 - Press any key to confirm the record;

- After recorded message is confirmed:
 - Then, {
 - Press "1" to send message;
 - Press "2" to replay recorded message;
 - Press “3” to erase and record message again;

Forward Message

- Enter voice mailbox number you forward;
- After number is entered:
 - Then, {
 - Press "1" to send message;
 - Press “2” to forward message to other number;

Advanced Call Features

Call Waiting

Whenever you detect a Call Waiting Tone during a telephone conversation, an incoming call is waiting to be answered.

To enable Call Waiting:

- Press *68.

To pick the call:

- Press .



To reject the call:

- Press .

To disable Call Waiting:

- Press #68.

You can disregard the new incoming caller per call basis:

- Cancel Call Waiting before making a call,
 1. Dial *87, and hear confirmation tone
 2. When you hear dial tone again, dial outgoing call
- Cancel Call Waiting during call
 1. Press  during an active call. The call is placed on hold.
 2. Dial *87
 3. After confirmation tone, press  and  to resume conversation

Note: It is highly recommended to use the access code to set call waiting rather than SIP phone menu configuration.

Speed Dialing

Speed dialing allows you to store up your most frequently called numbers in memory. Calls can be connected more quickly by dialing codes with either one or two digits.

For one digit:

- Press *92
- Enter 1-digit code (2-9)
- Dial a telephone number + #

For two digits:

- Press *91
- Enter 2-digit code (20-39)
- Dial a telephone number + #

Note: It is highly recommended to use the access code to set speed dial rather than SIP phone menu configuration.

Do-not-disturb

There are times when you just do not want to be interrupted. With Do-not-disturb, you are still able to make outgoing calls.

- Activate: Press *96
- Cancel: Press #96

Note: It is highly recommended to use the access code rather than SIP phone DND button  .

Call pick up

Give your colleagues a hand by picking their phones at your own telephone.

- Press *84 to pickup a call within same pickup group
- Press *85 + ringing extension number to pickup a call out of the pickup group

Note: Pickup group need to be created first. Please contact HKBN for feature amendment.

Support

Contact Us

Business Customer Service Hotline: 128 180
Technical Support Hotline: 2131 2131
Email address: cscorp@hkbnes.net
Website: <http://hkbnes.net>